

TRACK WIRE HOLDER SET

- ◆ MATERIAL: NYLON 66 (UL)
- ◆ FLAME CLASS: 94V-2/94V-0
- ◆ COLOR: BLACK
- ◆ UNIT: mm

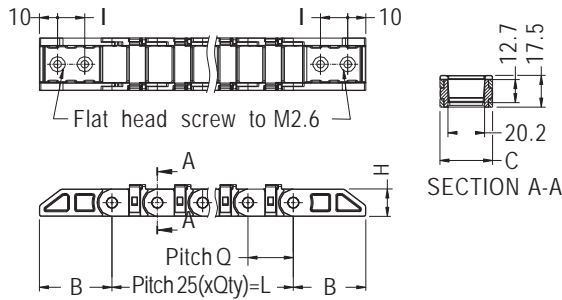

PART NO	B	C	H	I	Q
GULY-6AB-XXF	40.0	29.0	15.1	15.0	25.0

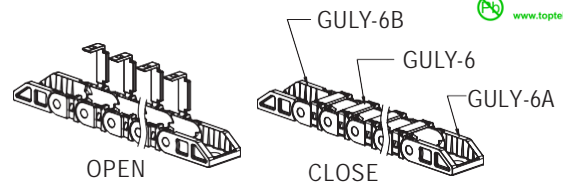
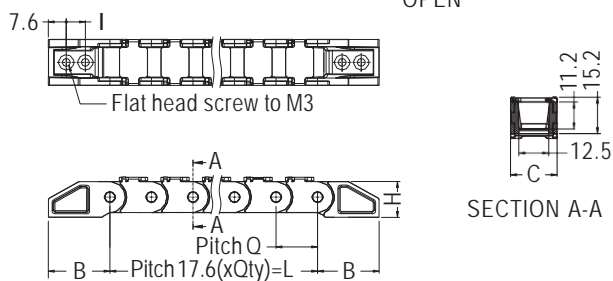
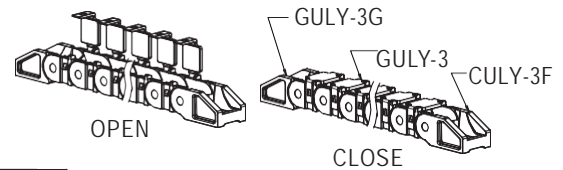
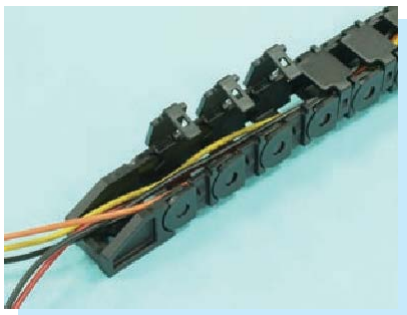

PART NO	B	C	H	I	Q
GULY-3FG-XXF	26.1	19.5	15.2	8.1	17.6

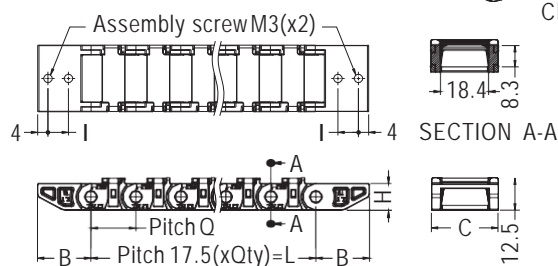
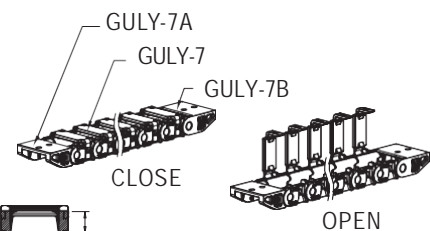

PART NO	B	C	H	I	Q
GULY-7AB-XXF	20.85	26.0	10.3	8.0	17.5