

# WIRE MOUNT

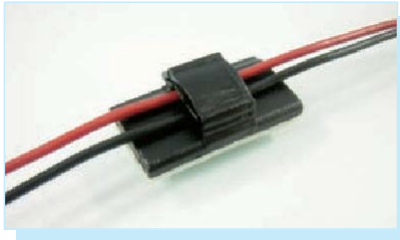

- ◆ MATERIAL: NYLON 66 (UL)
- ◆ FLAME CLASS: 94V-2/94V-0
- ◆ COLOR: NATURAL/BLACK
- ◆ UNIT: mm

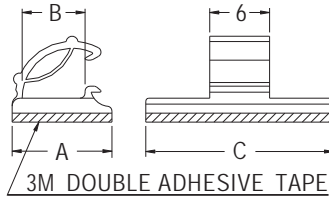

PART NO	A	B	C	PACKAGE
WCC-1	10.0	6.3	19.0	1000
WCC-1S	10.0	6.3	11.0	1000
WCC-2	14.0	10.5	19.0	500
WCC-8	10.0	6.0	19.5	1000

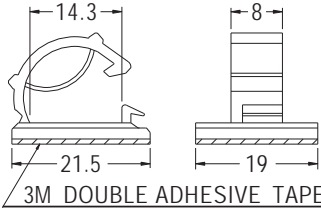

PART NO	PACKAGE
WCC-3	500

# WIRE MOUNT

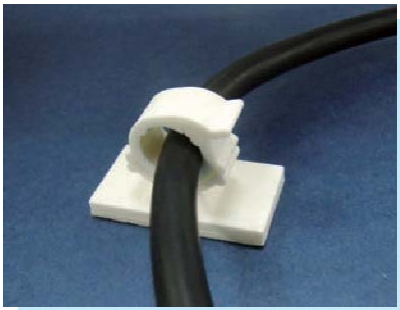

- ◆ MATERIAL: NYLON 66 (UL)
- ◆ FLAME CLASS: 94V-2/94V-0
- ◆ COLOR: NATURAL/WHITE/BLACK
- ◆ UNIT: mm

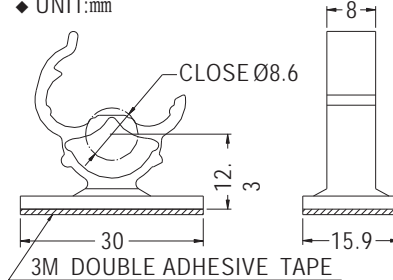

PART NO	PACKAGE
WSK-1	1000

# WIRE MOUNT



- ◆ MATERIAL: NYLON 66 (UL)
- ◆ FLAME CLASS: 94V-2
- ◆ COLOR: NATURAL
- ◆ UNIT: mm

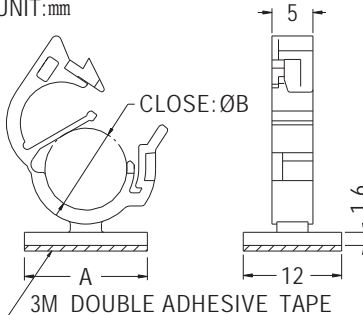

PART NO	A	B	PACKAGE
CHO-7.6	15.0	7.6	500
CHO-10	19.0	10.0	
CHO-12	20.0	12.0	

# WIRE MOUNT



- ◆ MATERIAL: NYLON 66 (UL)
- ◆ FLAME CLASS: 94V-2/94V-0
- ◆ COLOR: NATURAL/BLACK
- ◆ UNIT: mm

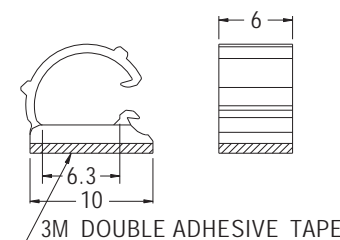

PART NO	PACKAGE
WCC-5	1000

