

WIRE MOUNT

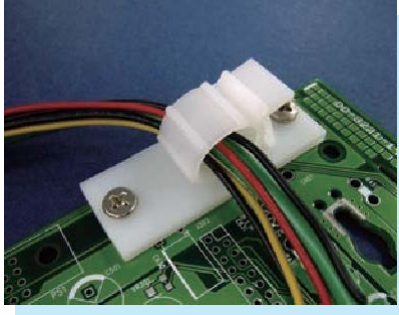

- ◆ MATERIAL: NYLON 66 (UL)
- ◆ FLAME CLASS: 94V-2/94V-0
- ◆ COLOR: NATURAL/BLACK
- ◆ UNIT: mm

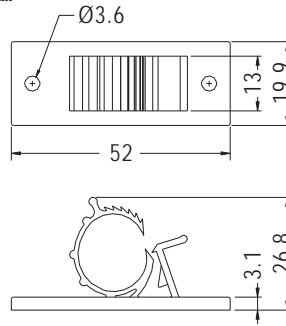

PART NO	PACKAGE
AWCA-1N	1000

WIRE MOUNT

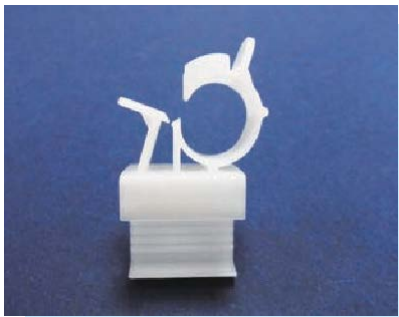

- ◆ MATERIAL: NYLON 66 (UL)
- ◆ FLAME CLASS: 94V-2/94V-0
- ◆ COLOR: NATURAL/BLACK
- ◆ UNIT: mm

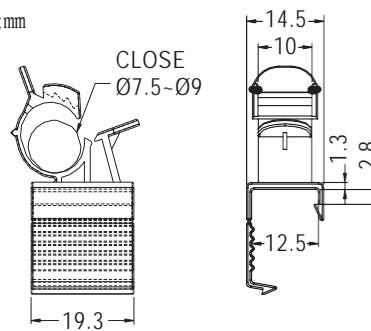

PART NO	PACKAGE
AWCB-1	500

WIRE MOUNT



- ◆ MATERIAL: NYLON 66 (UL)
- ◆ FLAME CLASS: 94V-2/94V-0
- ◆ COLOR: NATURAL/BLACK
- ◆ UNIT: mm

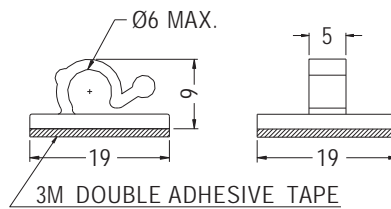

PART NO	PACKAGE
WRA-6	1000

WIRE MOUNT

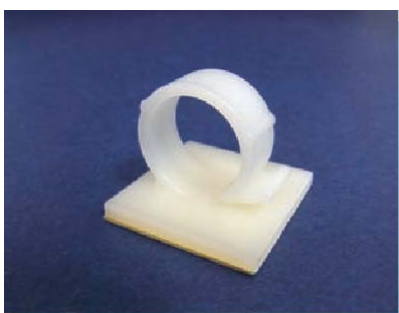

- ◆ MATERIAL: NYLON 66 (UL)
- ◆ FLAME CLASS: 94V-2/94V-0
- ◆ COLOR: NATURAL/BLACK
- ◆ UNIT: mm

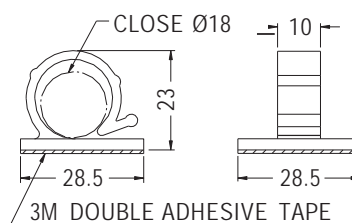

PART NO	PACKAGE
WRA-18	500