

WIRE MOUNT

- ◆ MATERIAL: NYLON 66 (UL)
- ◆ FLAME CLASS: 94V-2/94V-0
- ◆ COLOR: NATURAL/BLACK
- ◆ UNIT: mm

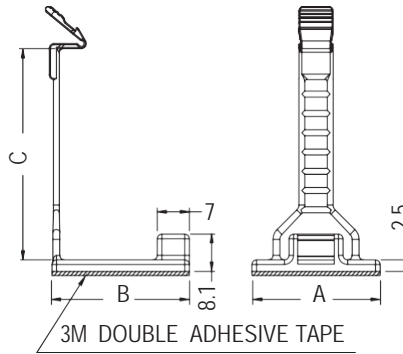

PARTNO	A	B	C	PACKAGE
CLE-3	28.0	30.0	46.0	200

WIRE MOUNT

- ◆ MATERIAL: NYLON 66 (UL)
- ◆ FLAME CLASS: 94V-2/94V-0
- ◆ COLOR: NATURAL/BLACK
- ◆ UNIT: mm

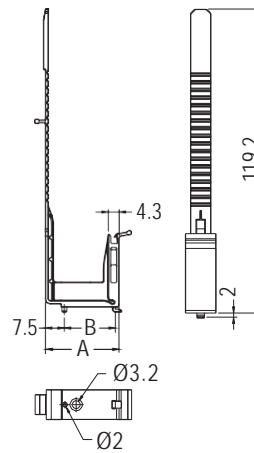
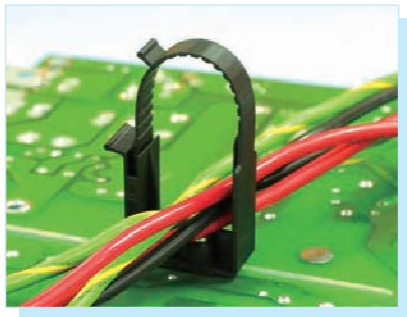

PARTNO	A	B	PACKAGE
CLF-2	29.2	20.2	500
CLF-3	24.2	15.2	

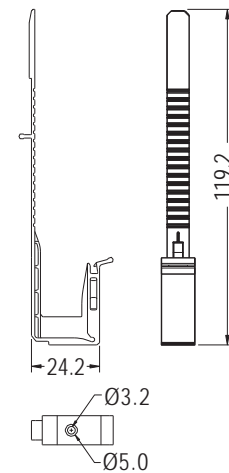

PARTNO	A	PACKAGE
★ CLF-4	24.2	500

WIRE MOUNT



- ◆ MATERIAL: NYLON 66 (UL)
- ◆ FLAME CLASS: 94V-2/94V-0
- ◆ COLOR: NATURAL/BLACK
- ◆ UNIT: mm

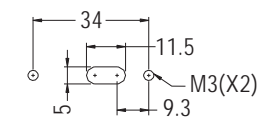
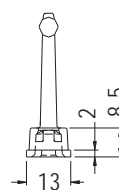
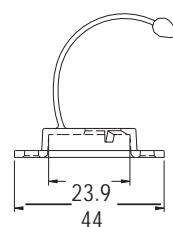

MOUNTING HOLES

PARTNO	PACKAGE
CLG-1	1000