

# HANDLE

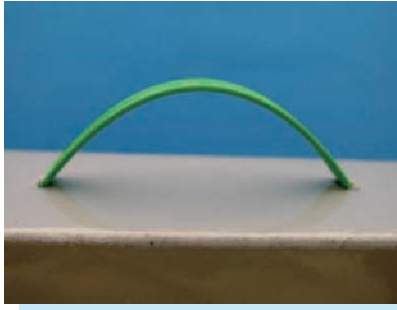

- ◆ MATERIAL: NYLON 66 (UL)
- ◆ FLAME CLASS: 94V-2/94V-0
- ◆ COLOR: NATURAL/BLACK/GREEN
- ◆ UNIT: mm

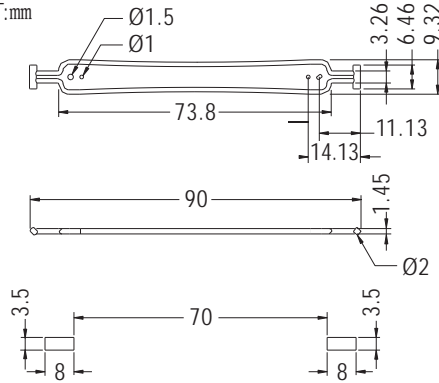

MOUNTING HOLES

PART NO	PACKAGE
HAND-7	500

# HANDLE



- ◆ MATERIAL: PE
- ◆ COLOR: BLACK
- ◆ UNIT: mm

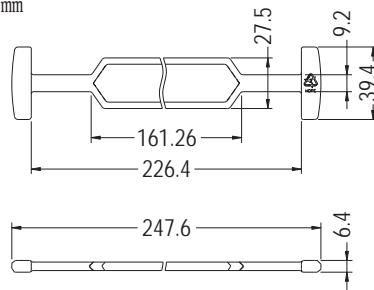

PART NO	PACKAGE
HAND-12	100

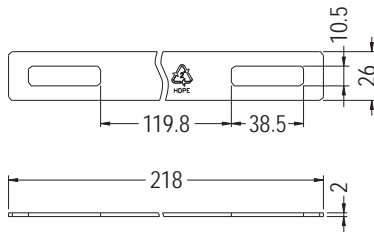

PART NO	PACKAGE
HAND-13	100

# HANDLE

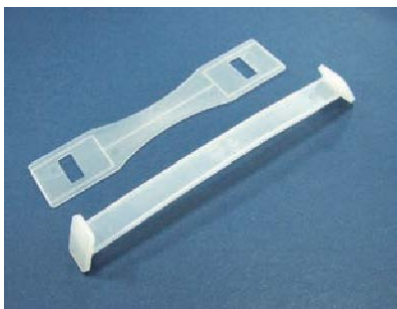

- ◆ MATERIAL: PE/PP
- ◆ COLOR: NATURAL
- ◆ UNIT: mm

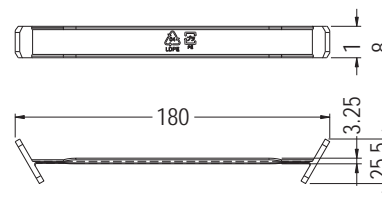

PART NO	PACKAGE
HAND-23A	100

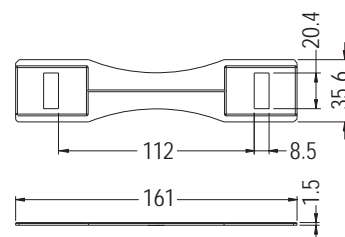

PART NO	PACKAGE
HAND-23B	100

