

IR TRANSISTOR HOUSING

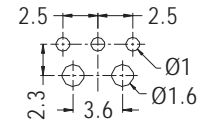

- ◆ MATERIAL:NYLON 66 (UL)
- ◆ FLAME CLASS:94V-2/94V-0
- ◆ COLOR:NATURAL/BLACK
- ◆ UNIT:mm

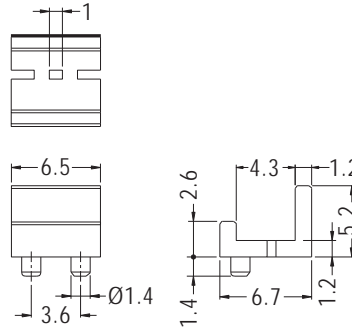

MOUNTING HOLES

PART NO	PACKAGE
TRAB-1	1000

IR TRANSISTOR HOUSING



- ◆ MATERIAL:NYLON 66 (UL)
- ◆ FLAME CLASS:94V-2/94V-0
- ◆ COLOR:NATURAL/BLACK
- ◆ UNIT:mm

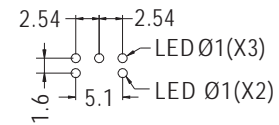
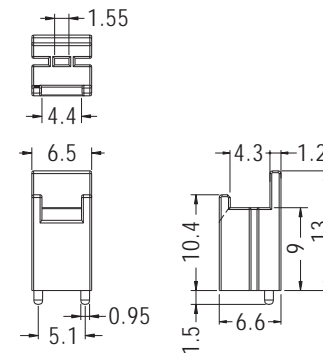

MOUNTING HOLES

PART NO	PACKAGE
TRAC-9	1000

IR RECEIVER HOLDER

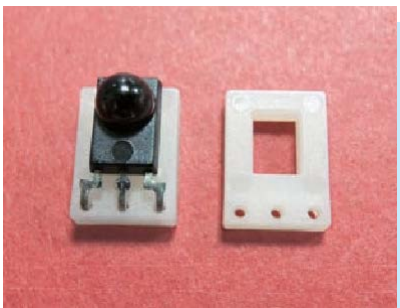

- ◆ MATERIAL:NYLON 66 (UL)
- ◆ FLAME CLASS:94V-2/94V-0
- ◆ COLOR:NATURAL/BLACK
- ◆ UNIT:mm

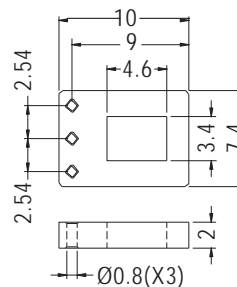

PART NO	PACKAGE
RCEA-2	1000

IR RECEIVER HOLDER

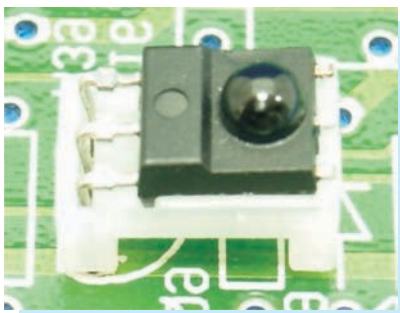

- ◆ MATERIAL:NYLON 66 (UL)
- ◆ FLAME CLASS:94V-2/94V-0
- ◆ COLOR:NATURAL/BLACK
- ◆ UNIT:mm

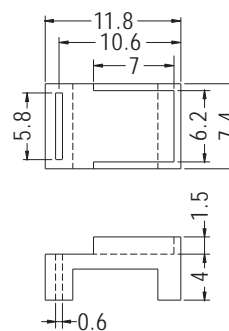

PART NO	PACKAGE
RCEA-4	1000