

SPEAKER HOLDER

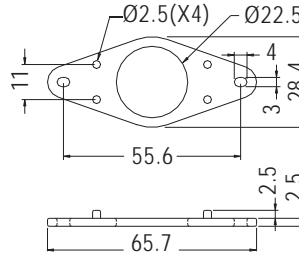

- ◆ MATERIAL: NYLON 66 (UL)
- ◆ FLAME CLASS: 94V-2/94V-0
- ◆ COLOR: NATURAL/BLACK
- ◆ UNIT: mm



PART NO	PACKAGE
SPK-1	250

SPEAKER HOLDER

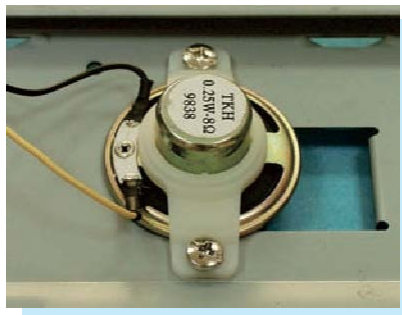

- ◆ MATERIAL: NYLON 66 (UL)
- ◆ FLAME CLASS: 94V-2/94V-0
- ◆ COLOR: NATURAL/BLACK
- ◆ UNIT: mm

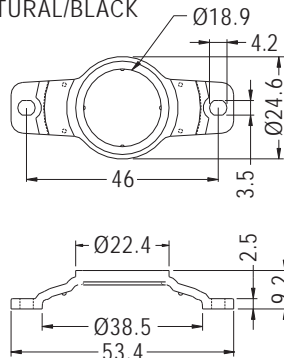

PART NO	PACKAGE
SPK-2	250

LOUDSPEAKER BUCKLE



- ◆ BODY MATERIAL: TPE
- ◆ PIN MATERIAL: NYLON 66 (UL)
- ◆ COLOR: BLACK
- ◆ UNIT: mm

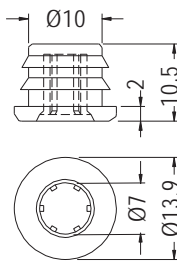

CHASSIS Ø10.5
THICKNESS 2.5

PART NO	PACKAGE
SPLK-1FA	500

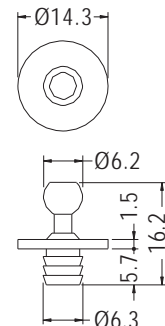

CHASSIS Ø6.1
THICKNESS 6.4

PART NO	PACKAGE
SPLK-1FB	500

- ◆ BODY MATERIAL: TPU
- ◆ PIN MATERIAL: NYLON 66 (UL)
- ◆ COLOR: BLACK
- ◆ UNIT: mm

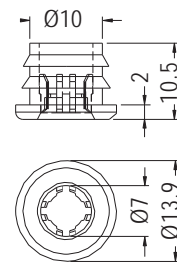

CHASSIS Ø10.5
THICKNESS 2.5

PART NO	PACKAGE
SPLK-2FA	500

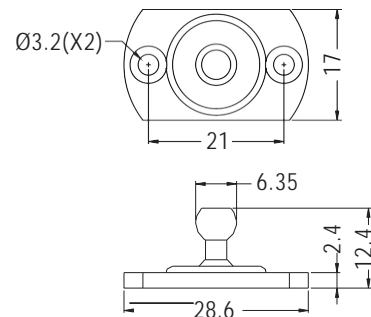

PART NO	PACKAGE
SPLK-2FB	500

