

CARD GUIDE

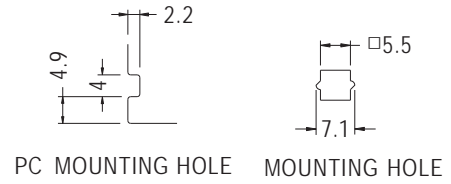

- ◆ MATERIAL: NYLON 66 (UL)
- ◆ FLAME CLASS: 94V-2/94V-0
- ◆ COLOR: NATURAL/BLACK
- ◆ UNIT: mm

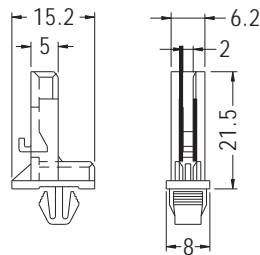

CHASSIS THICKNESS 1.0-2.0

PART NO	PACKAGE
CGH-1	500

CARD GUIDE

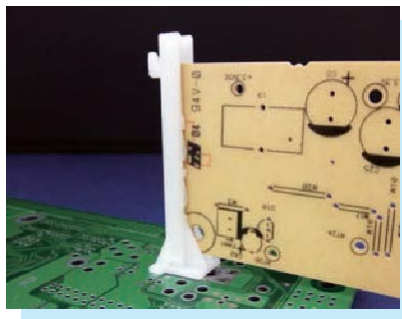

- ◆ MATERIAL: NYLON 66 (UL)
- ◆ FLAME CLASS: 94V-2/94V-0
- ◆ COLOR: NATURAL/BLACK
- ◆ UNIT: mm

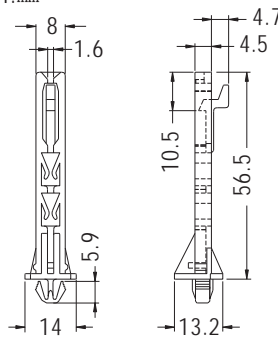

PCB DIM.

PART NO	PACKAGE
CGHI-1	500

CARD GUIDE

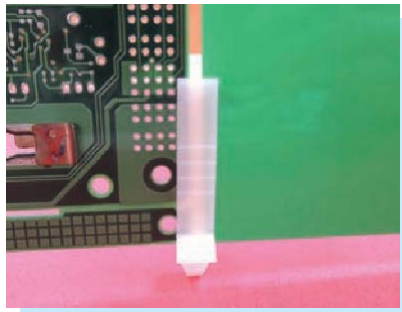

- ◆ MATERIAL: NYLON 66 (UL)
- ◆ FLAME CLASS: 94V-2/94V-0
- ◆ COLOR: NATURAL/BLACK
- ◆ UNIT: mm

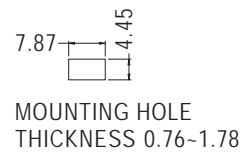
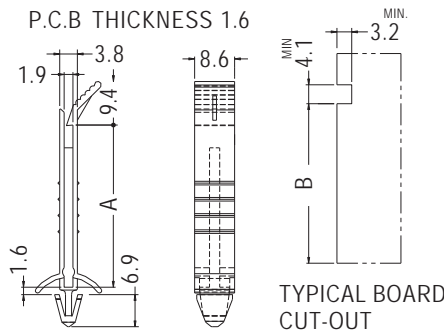

PART NO	A	B	PACKAGE
CGHE-22.4	22.4	22.0	
CGHE-34.9	34.9	34.5	500
CGHE-47.5	47.5	47.1	
CGHE-73.0	73.0	72.6	

CARD GUIDE

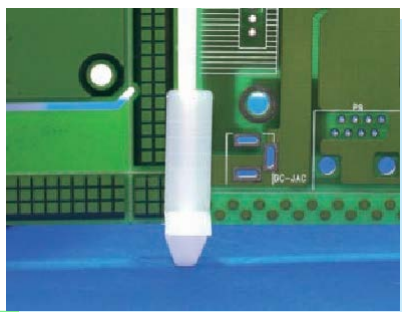

- ◆ MATERIAL: NYLON 66 (UL)
- ◆ FLAME CLASS: 94V-2/94V-0
- ◆ COLOR: NATURAL/BLACK
- ◆ UNIT: mm

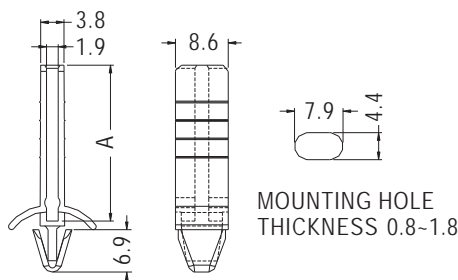

PART NO	A	PACKAGE
CGHC-25.4	25.4	
CGHC-38.1	38.1	500
CGHC-50.8	50.8	
CGHC-76.2	76.2	200

