

1.0mm Wafer SMT Straight & SMT Right Angle Type

Specifications
 Current Rating: 1A AC,DC
 Voltage Rating: 50V AC,DC
 Temperature Range: -25°C to +85°C
 Contact Resistance: 20mΩ Max
 Insulation Resistance: 100MΩ Min
 Withstanding Voltage: 500V AC/minute
 Terminal: Phosphor Bronze / Gold or Tin Plated
 Solder Tabs: Brass / Gold or Tin Plated
 Material: Nylon 6T, UL94V-0

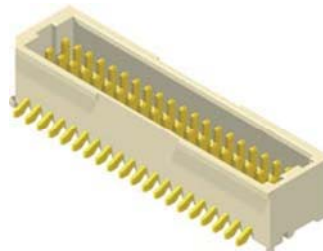
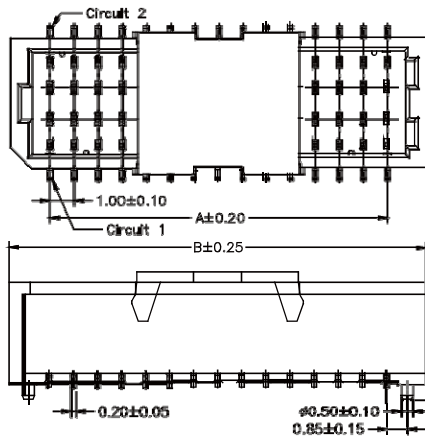
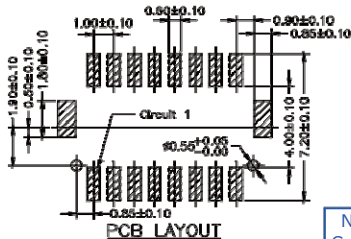

No. of Contacts	Dimensions		No. of Contacts	Dimensions	
	A	B		A	B
2x6	5.00	9.10	2x15	14.00	18.10
2x8	7.00	11.10	2x20	19.00	23.10
2x10	9.00	13.10	2x25	24.00	28.10

Part No.:1001MS-2XXGW -U

1:With Post
2:W/O Post

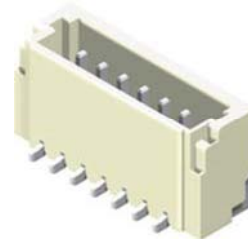
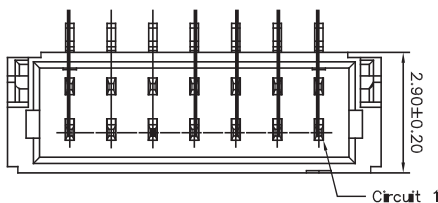

No. of Contacts	Dimensions	
	A	B
2	1.00	4.00
3	2.00	5.00
4	3.00	6.00
5	4.00	7.00
6	5.00	8.00
7	6.00	9.00
8	7.00	10.00
9	8.00	11.00
10	9.00	12.00
11	10.00	13.00
12	11.00	14.00
13	12.00	15.00
14	13.00	16.00
15	14.00	17.00
16	15.00	18.00
17	16.00	19.00
18	17.00	20.00
19	18.00	21.00
20	19.00	22.00

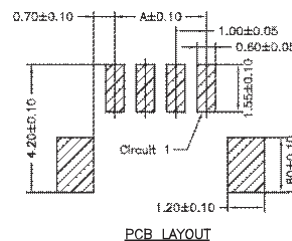
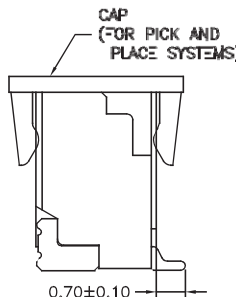
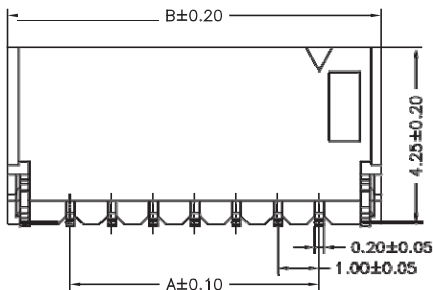

Part No.:1001MS-1XXTW-U

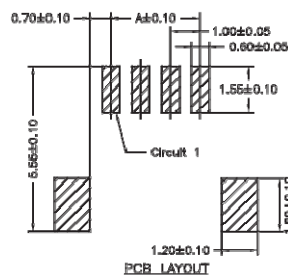
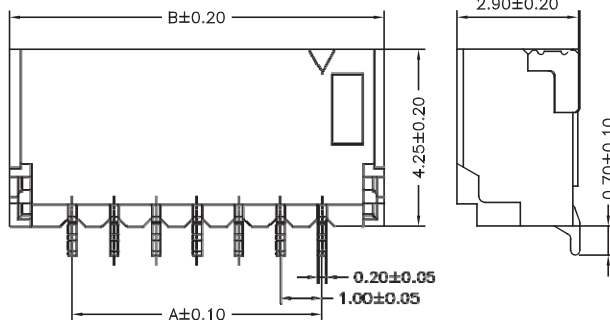
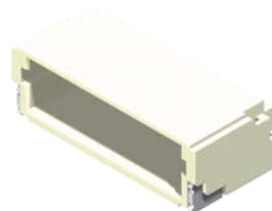
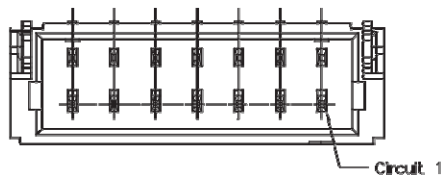

Part No.:1001MR-1XXTW-U