

P.C.B TERMINAL

- ◆ MATERIAL:TIN PLATED BRASS
- ◆ UNIT:mm

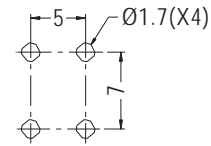
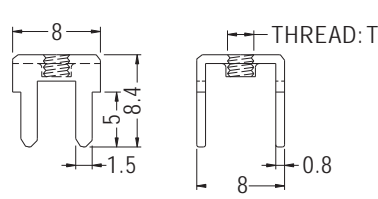

MOUNTING HOLES

PART NO	T	PACKAGE
PCB-1	M3X0.5P	1000
PCB-1(M4)	M4X0.7P	
PCB-1(6-32)	6-32UNC	

P.C.B TERMINAL

- ◆ MATERIAL:TIN PLATED BRASS
- ◆ UNIT:mm

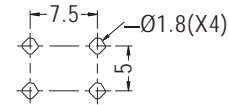
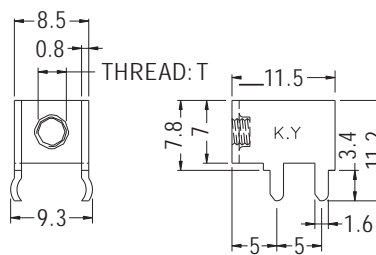
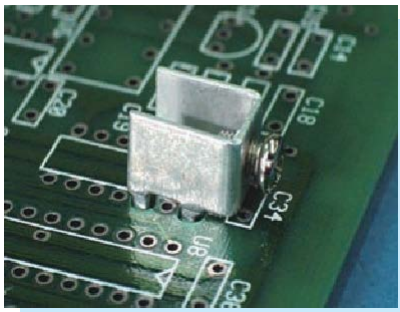

MOUNTING HOLES

PART NO	T	PACKAGE
PCB-2	M3X0.5P	1000
PCB-2(M4)	M4X0.7P	
PCB-2(6-32)	6-32UNC	

P.C.B TERMINAL

- ◆ MATERIAL:TIN PLATED BRASS
- ◆ UNIT:mm

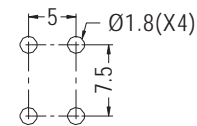
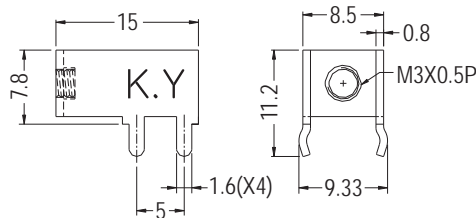

MOUNTING HOLES

PART NO	PACKAGE
PCB-78	1000

P.C.B TERMINAL

- ◆ MATERIAL:TIN PLATED BRASS
- ◆ UNIT:mm

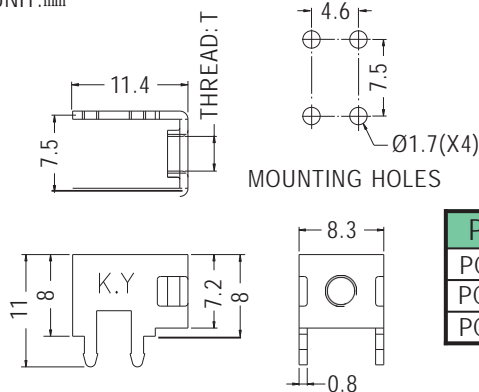
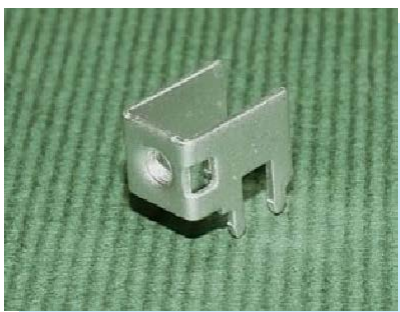

MOUNTING HOLES

PART NO	T	PACKAGE
PCB-12	M3X0.5P	1000
PCB-12(M4)	M4X0.7P	
PCB-12(632)	6-32UNC	

