

▶ D SUB CONNECTORS

D-SUB Press Fit Type



RoHS 2002/95/EC

Specifications

Current Rate: 3 AMP | Insulation Resistance: 1000MΩ Min. | Contact Resistance: 20mΩ Max. | Dielectric Voltage: 500V AC for one minute | Operation Temperature: -55°C to +105°C

Material

Contacts: Copper Alloy | Insulator: PBT UL 94V-0 Rated

TOPTTEK[®]

HARDWARE ELECTRONIC COMPONENTS



www.toptek-co.com

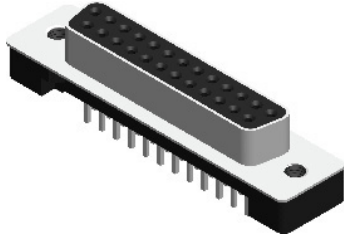

▶ ORDER INFORMATION

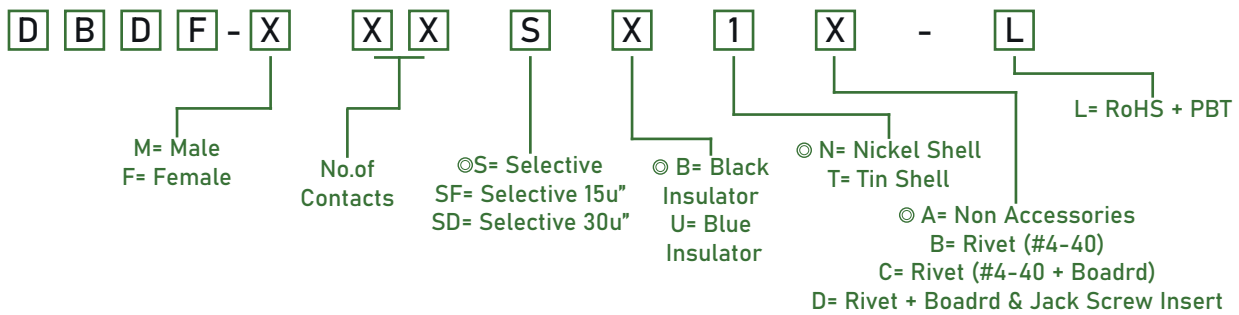

No. of Contacts	Dim. A	Dim. B	Dim. C	Dim. D	Dim. E
9	30.81	24.99	16.92	16.33	11.08
15	39.14	33.32	25.50	24.66	19.39
25	53.04	47.04	38.96	38.38	33.24
37	69.32	63.50	55.42	54.84	49.86

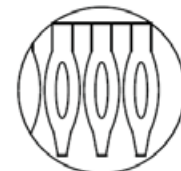
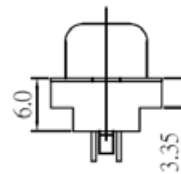
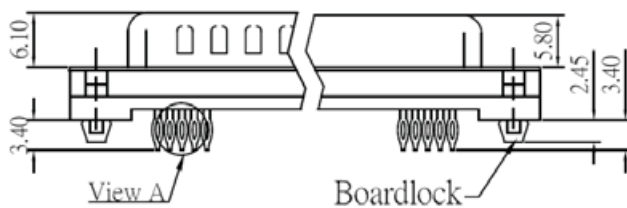
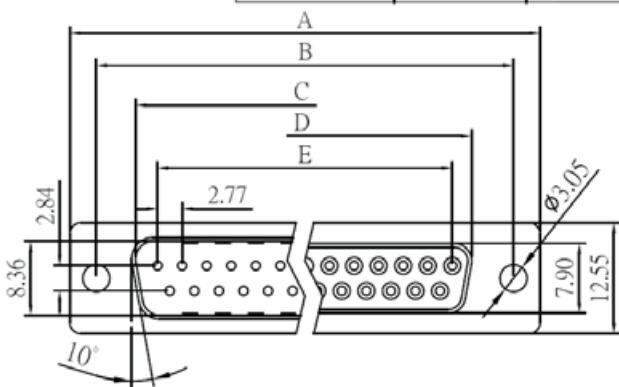

View A=5:1

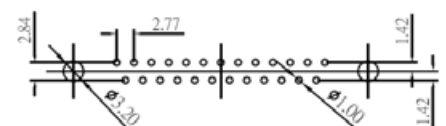

Recommended PCB Layout (PCB TOLERANCE ±0.05)