

Hood / Cable

TOPTEK®

HARDWARE ELECTRONIC MANUFACTURER

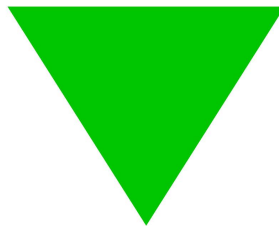

www.toptek-co.com

TOPTEK srl
10015 - IVREA (TO) - ITALY
tel. +39 0125 251 211 - fax +39 0341 367 607
info@toptek-co.com

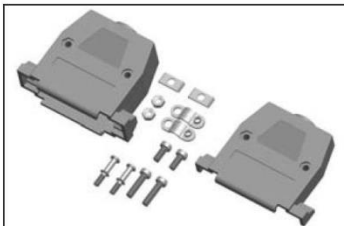

HOOD101 - XX X Y - L
1 2 3

- 1.No. of Contacts(09,15,25,37)
- 2.G:Gray B:Black C:Chrome
- 3.RoHS + ABS

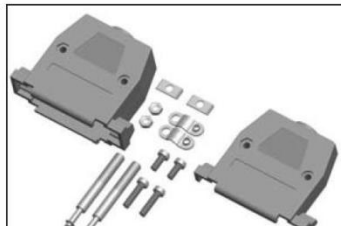

HOOD102 - XX X Y - L
1 2 3

- 1.No. of Contacts(09,15,25,37)
- 2.G:Gray B:Black C:Chrome
- 3.RoHS + ABS



HOOD103 - XX X Y - L
1 2 3

- 1.No. of Contacts(09,15,25,37)
- 2.G:Gray B:Black C:Chrome
- 3.RoHS + ABS

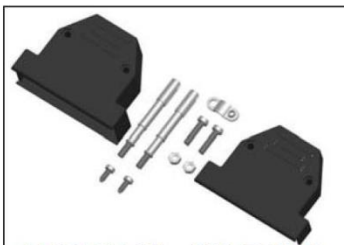

HOOD105 - XX B Y - L
1 2 3

- 1.No. of Contacts(09,15,25,37)
- 2.B:Black
- 3.RoHS + ABS

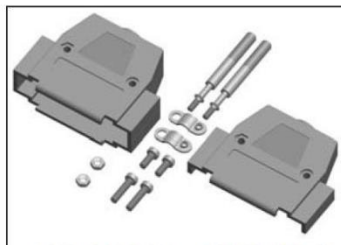

HOOD106 - XX X Y - L
1 2 3

- 1.No. of Contacts(09,15,25)
- 2.G:Gray B:Black C:Chrome
- 3.RoHS + ABS

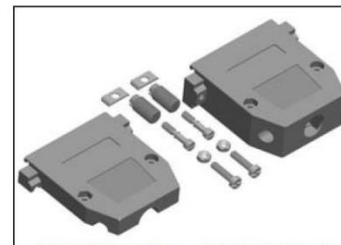

HOOD107 - XX X Y - L
1 2

- 1.No. of Contacts(09,15,25,37)
- 2.G:Gray B:Black C:Chrome
- 3.RoHS + ABS

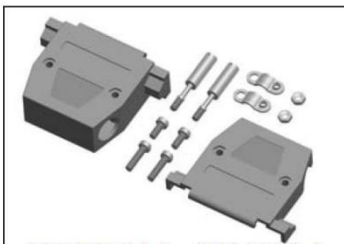

HOOD114 - XX X Y - L
1 2 3

- 1.No. of Contacts(09,15,25,37)
- 2.G:Gray B:Black C:Chrome
- 3.RoHS + ABS



HOOD115 - XX B Y - L
1 2 3

- 1.No. of Contacts(09,15,25)
- 2.B:Black
- 3.RoHS + ABS

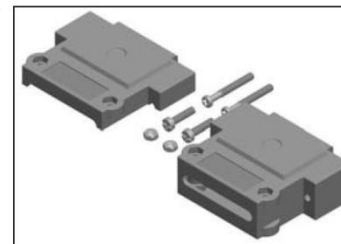

HOOD115 - IDC - XX X Y - L
1 2 3

- 1.No. of Contacts(09,15,25,37)
- 2.G:Gray B:Black C:Chrome
- 3.RoHS + ABS

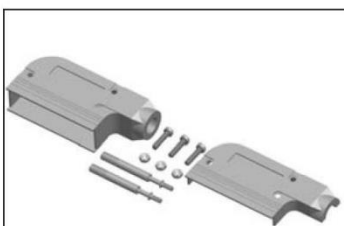

HOOD117 - XX DT - L
1 2

- 1.No. of Contacts(09,15,25)
- 2.RoHS + Steel

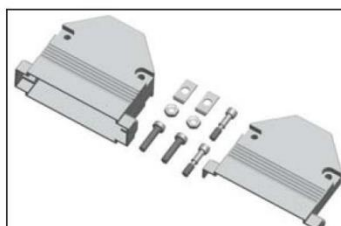

HOOD117 - XX V - L
1 2

- 1.No. of Contacts(09,15,25,37)
- 2.RoHS + Steel

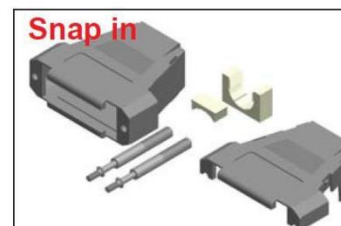

Snap in
HOOD118 - 25 X Y - L
1 2

- 1.G:Gray B:Black C:Chrome
- 2.RoHS + ABS

CONNECTORS MANUFACTURER

TOPTEK®
HARDWARE ELECTRONIC MANUFACTURER



14
*
2

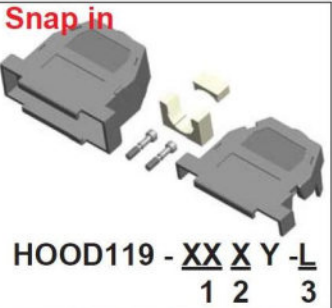

Snap in
HOOD119 - XX X Y -L
1 2 3
1.No. of Contacts(09,15,25)
2.G:Gray B:Black C:Chrome
3.RoHS + ABS

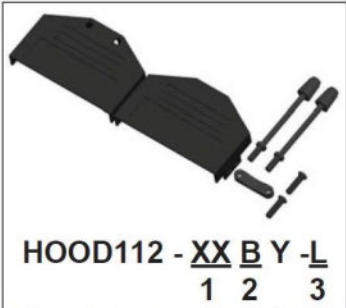

HOOD112 - XX B Y -L
1 2 3
1.No. of Contacts(09,15,25,37)
2.G:Gray B:Black C:Chrome
3.RoHS + ABS

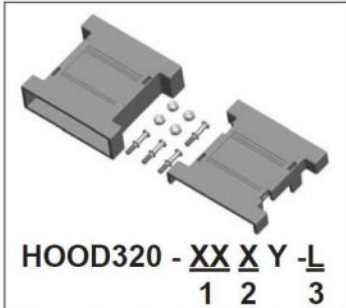

HOOD320 - XX X Y -L
1 2 3
1.No. of Contacts(09,15,25)
2.G:Gray B:Black C:Chrome
3.RoHS + ABS

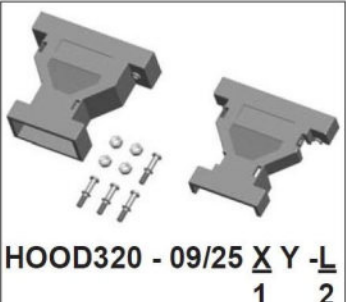

HOOD320 - 09/25 X Y -L
1 2
1.G:Gray B:Black C:Chrome
2.RoHS + ABS

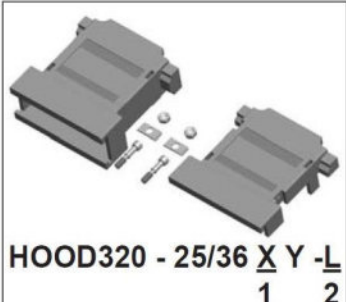

HOOD320 - 25/36 X Y -L
1 2
1.G:Gray B:Black C:Chrome
2.RoHS + ABS

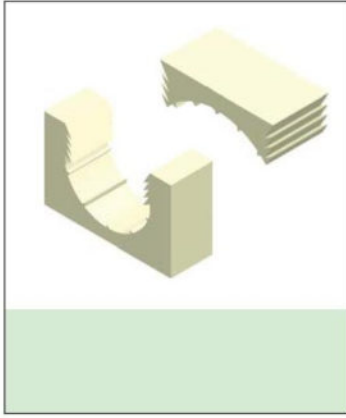
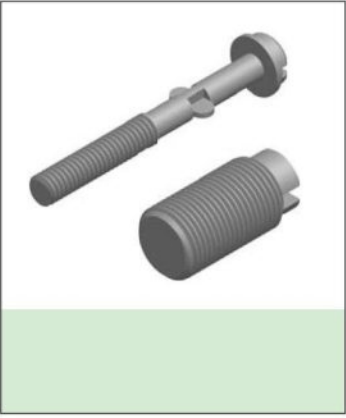

Hood



RoHS

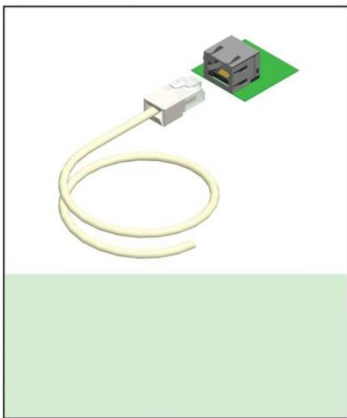
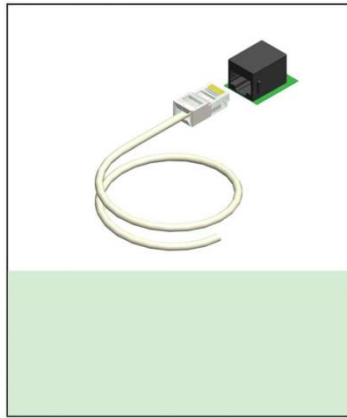
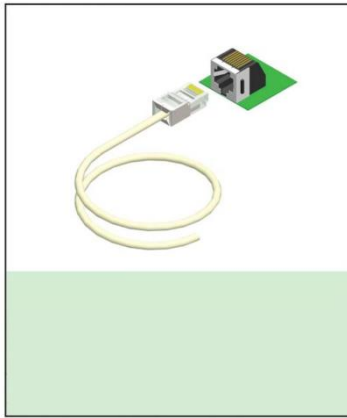
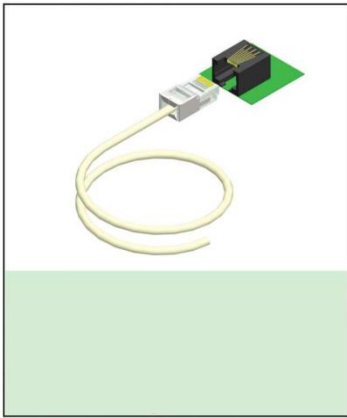

15
*
1



CONNECTORS MANUFACTURER



15
*
2

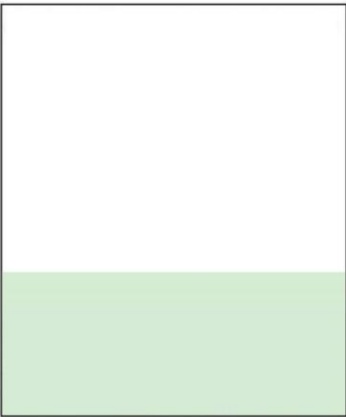
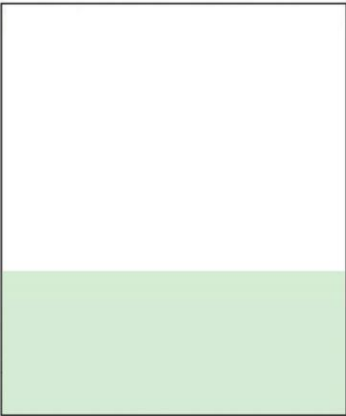
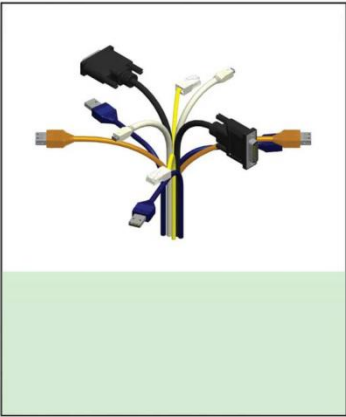
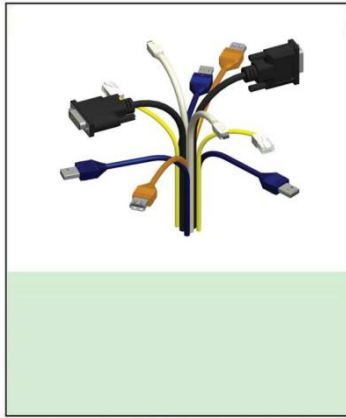
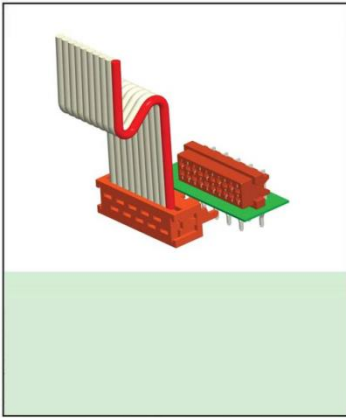
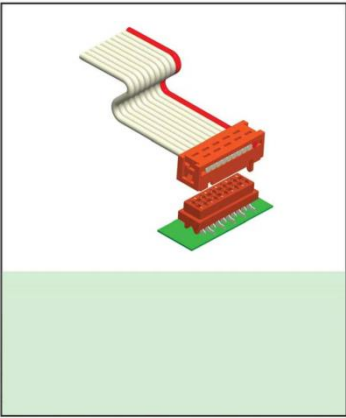

Cable



RoHS