

2.5mm Terminal / Housing / Wafer R/A / Straight Type

Specifications

Current Rating: 3A AC,DC
Voltage Rating: 250V AC,DC
Temperature Range: -25°C to +85°C
Contact Resistance: 10mΩ Max
Insulation Resistance: 1000MΩ Min
Withstanding Voltage: 1000V AC/minute
Terminal: Brass / Tin Plated
Material: Nylon 66, UL94V-0

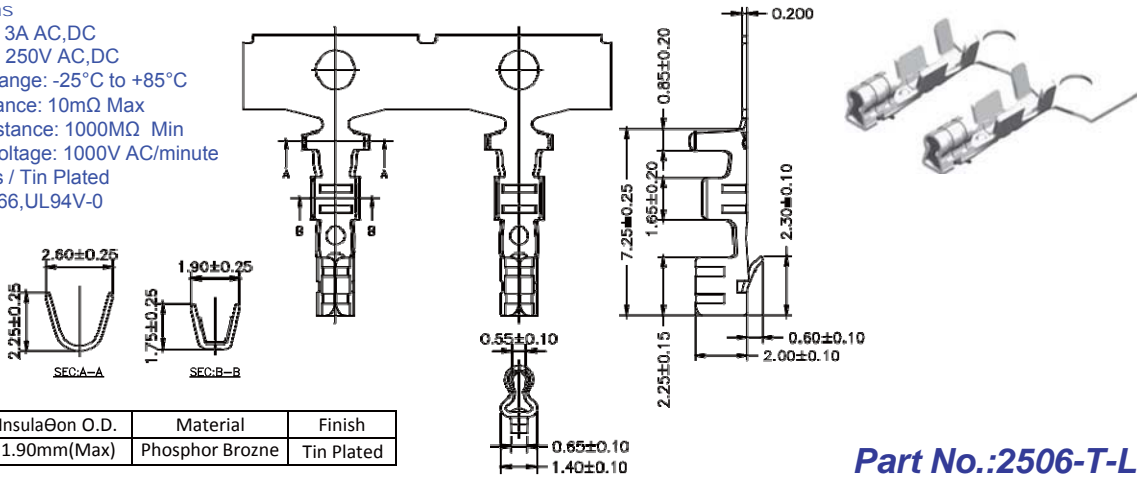

Wire Range	InsulaØon O.D.	Material	Finish
#22-#28	1.90mm(Max)	Phosphor Brozne	Tin Plated

Part No.:2506-T-L

No. of Contacts	Dimensions	
	A	B
2	2.50	5.80
3	5.00	8.30
4	7.50	10.80
5	10.00	13.30
6	12.50	15.80
7	15.00	18.30
8	17.50	20.80
9	20.00	23.30
10	22.50	25.80
11	25.00	28.30
12	27.50	30.80
13	30.00	33.30
14	32.50	35.80
15	35.00	38.30
16	37.50	40.80

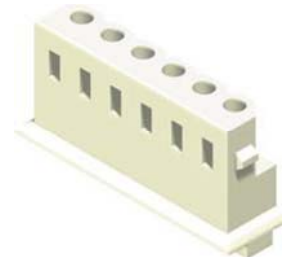
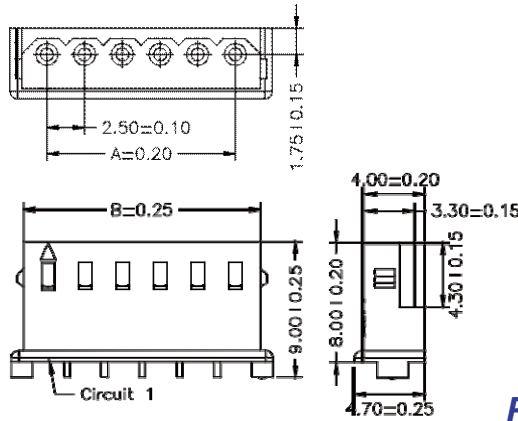

Part No.:2506H-XXW-L

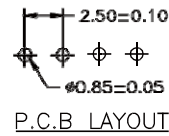
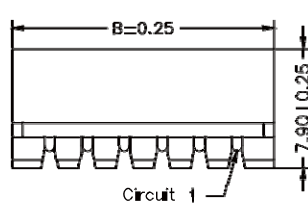
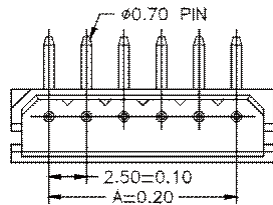

Part No.:2506R-XXTW-L

No. of Contacts	Dimensions	
	A	B
2	2.50	7.50
3	5.00	10.00
4	7.50	12.50
5	10.00	15.00
6	12.50	17.50
7	15.00	20.00
8	17.50	22.50
9	20.00	25.00
10	22.50	27.50
11	25.00	30.00
12	27.50	32.50
13	30.00	35.00
14	32.50	37.50
15	35.00	40.00
16	37.50	42.50

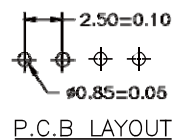
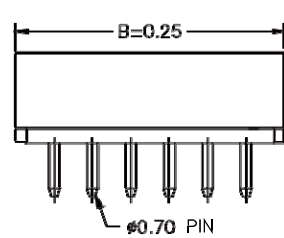
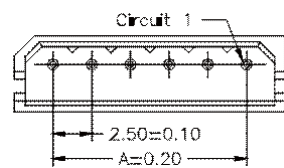

Part No.:2506S-XXTW-L

