

# PIN HEADER 1.0mm

Pin Header 1.0mm 1 Row H=1.0/1.5mm SMT Type

**TOPTTEK**<sup>®</sup>

HARDWARE ELECTRONIC COMPONENTS



www.toptek-co.com



## Specifications

Current Rate: 1 AMP | Insulation Resistance: 1000MΩ | Max. Contact Resistance: 20mΩ |  
Max. Dielectric Voltage: 500V AC for one minute | Operation Temperature: -40°C to +105°C

## Material

Insulator: Polyester, UL 94V-0 | Standard: Nylon 6T | Terminal: Copper Alloy | Plating: Gold Plated

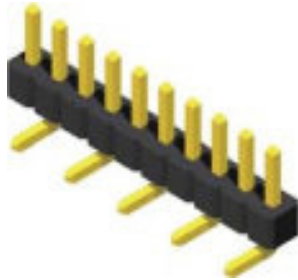

## ORDER INFORMATION

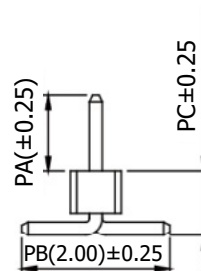
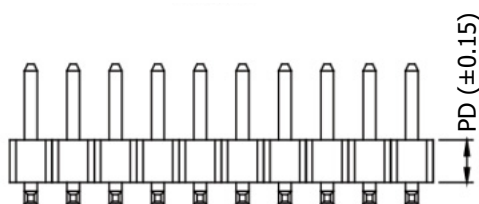
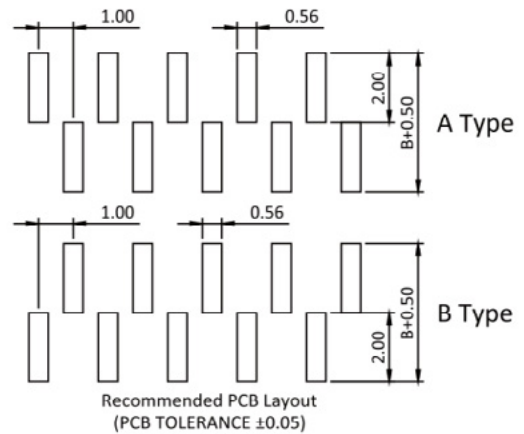
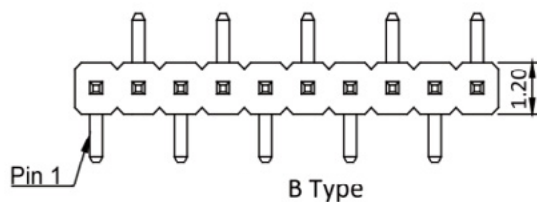
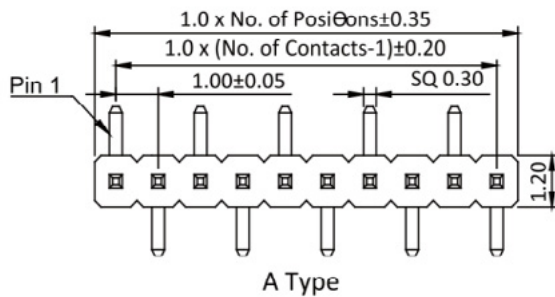
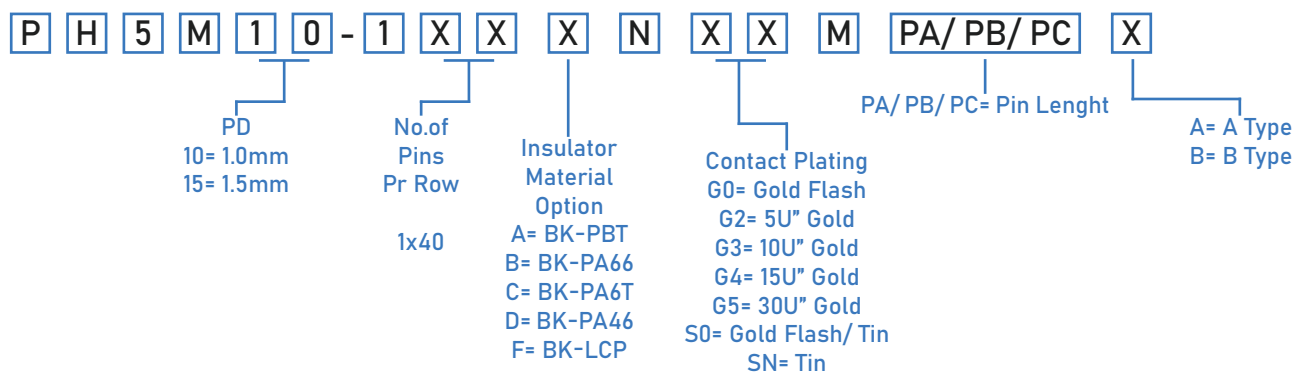

PD
1.00mm
1.50mm

ITEM	PA	PC	PB
Standard	1.80	1.50	3.50
Alternate			