

# CONNECTORS MANUFACTURER

## Modular Jack Side Entry H=14.5 W=13.0

Material & Finish:  
 Housing:Glass Fiber,PBT. UL94V-0,Black  
 Contact:0.45 mm Thickness Phosphor Bronze,  
 Gold Plating Over Nickel on Contact Area,  
 Tin Plating Over Nickel on Solder Area.

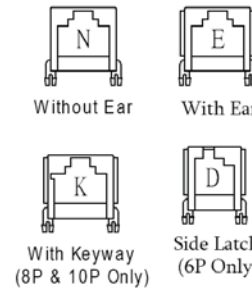
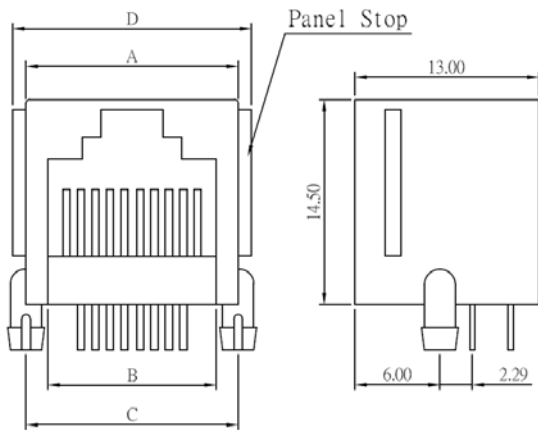
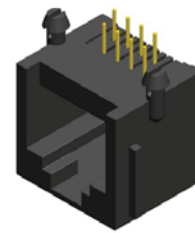

Positions	Contacts	A	B	C	D
4P	4C	10.00	7.85	10.00	12.00
(6P)4P	4C	12.20	7.85	12.00	14.20
6P	2C/4C/6C	12.20	9.90	12.00	14.20
8P	8C	15.00	11.85	15.00	16.90
10P	10C	15.00	11.85	15.00	16.90

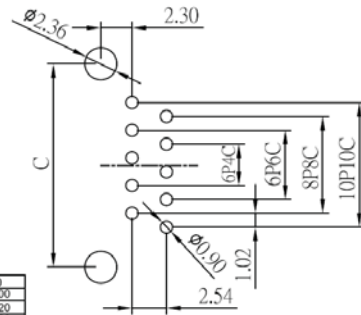

Recommended PCB Layout  
(PCB TOLERANCE ±0.05)

### Order Information

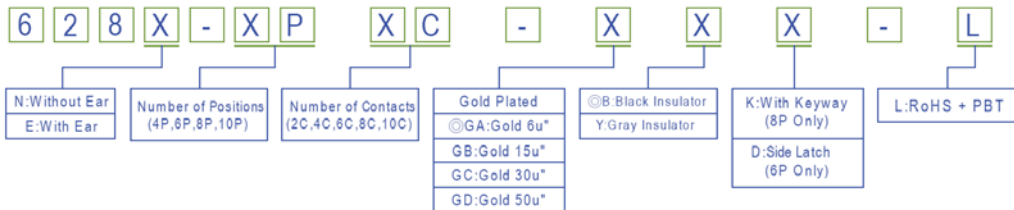

## Modular Jack Side Entry H=14.5 W=14.0

Material & Finish:  
 Housing:Glass Fiber,PBT. UL94V-0,Black  
 Contact:0.45 mm Thickness Phosphor Bronze,  
 Gold Plating Over Nickel on Contact Area,  
 Tin Plating Over Nickel on Solder Area.

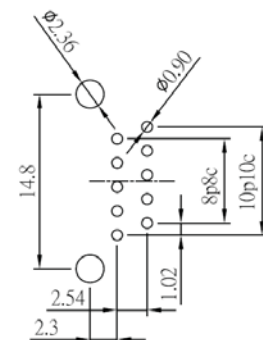
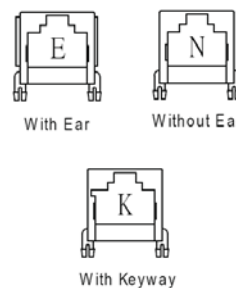
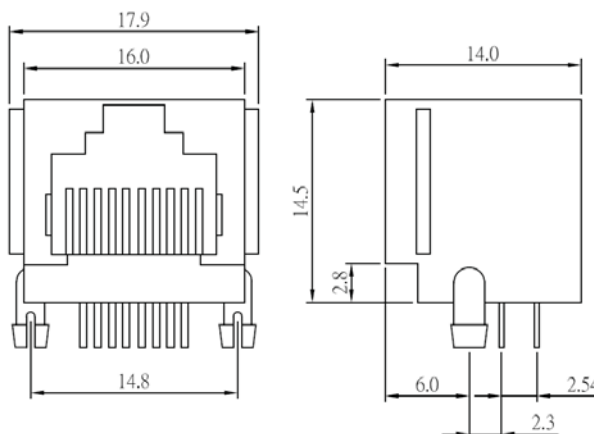
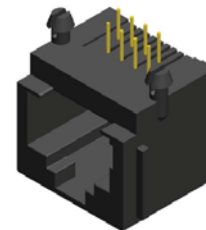

Recommended PCB Layout  
(PCB TOLERANCE ±0.05)

### Order Information

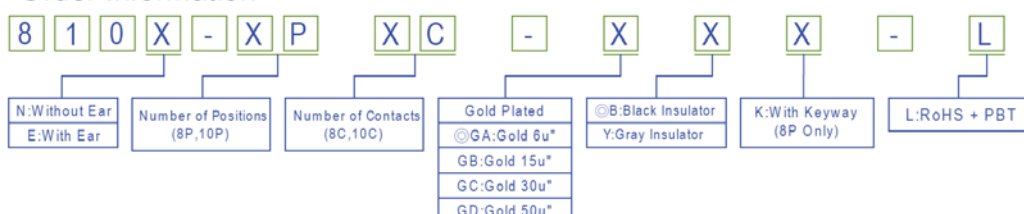

Modular Jack



RoHS