

CONNECTORS MANUFACTURER

DVI Conn. Series

DVI Female Right Angle 24Pin

SPECIFICATION

Current Rate: 1 AMP
 Insulation Resistance: 1000MΩ Min.
 Contact Resistance: 30mΩ Max.
 Dielectric Voltage: 250V AC for one minute
 Operation Temperature: -55°C to +85°C

MATERIAL

Insulator: Polyester, UL 94V-0
 © Standard: Nylon 66
 Contact Pin: Copper Alloy
 Contact Plating: Selective

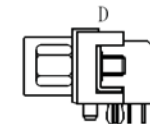
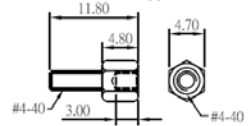
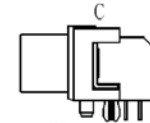
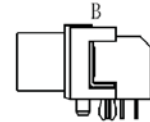
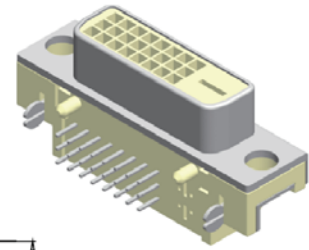
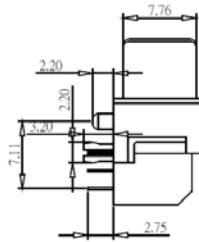
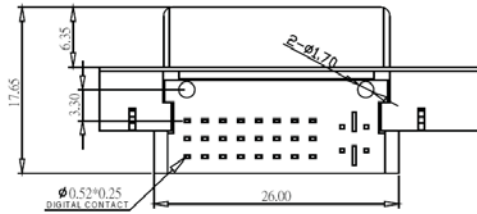
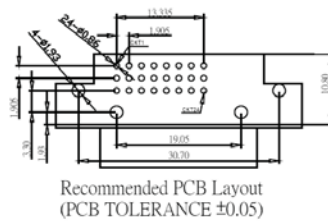
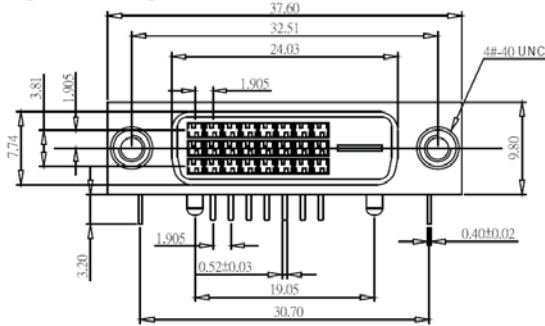

DVI Female Right Angle 29Pin

SPECIFICATION

Current Rate: 1 AMP
 Insulation Resistance: 1000MΩ Min.
 Contact Resistance: 30mΩ Max.
 Dielectric Voltage: 250V AC for one minute
 Operation Temperature: -55°C to +85°C

MATERIAL

Insulator: Polyester, UL 94V-0
 © Standard: Nylon 66
 Contact Pin: Copper Alloy
 Contact Plating: Selective

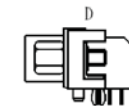
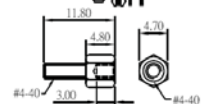
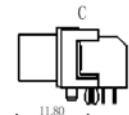
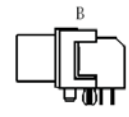
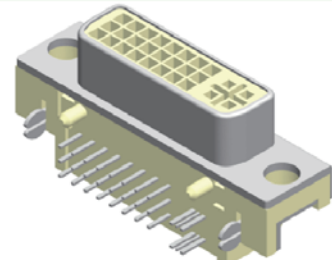
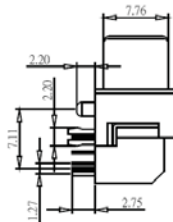
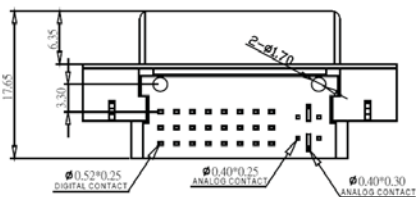
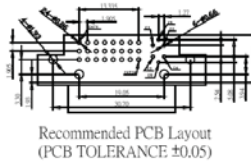
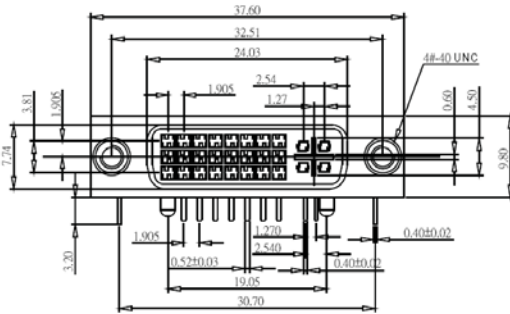

ORDER INFORMATION

