

FEMALE HEADER 2.54mm

Female Header 2.54mm 2 Row H=5.00mm SMT Type



Specifications

Current Rate: 3 AMP | Insulation Resistance: 1000MΩ | Min. Contact Resistance: 20mΩ |
 Max. Dielectric Voltage: 1000V AC for one minute | Operation Temperature: -40°C to +105°C

Material

Insulator: Polyester, UL 94V-0 | Standard: Nylon 6T | Terminal: Copper Alloy | Plating: Gold Plated

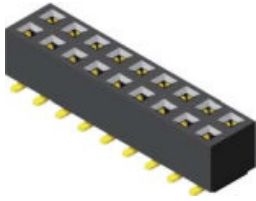

ORDER INFORMATION

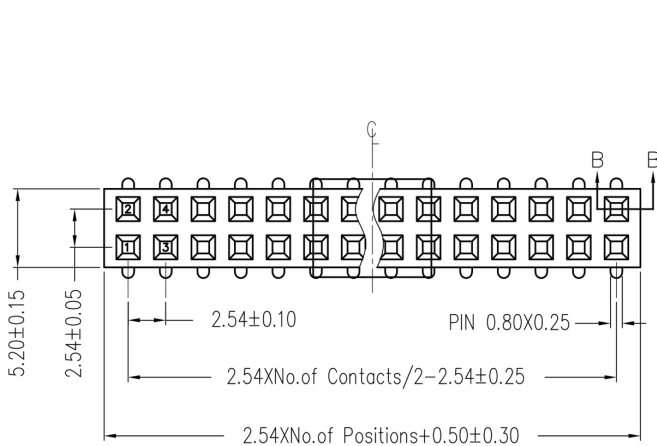
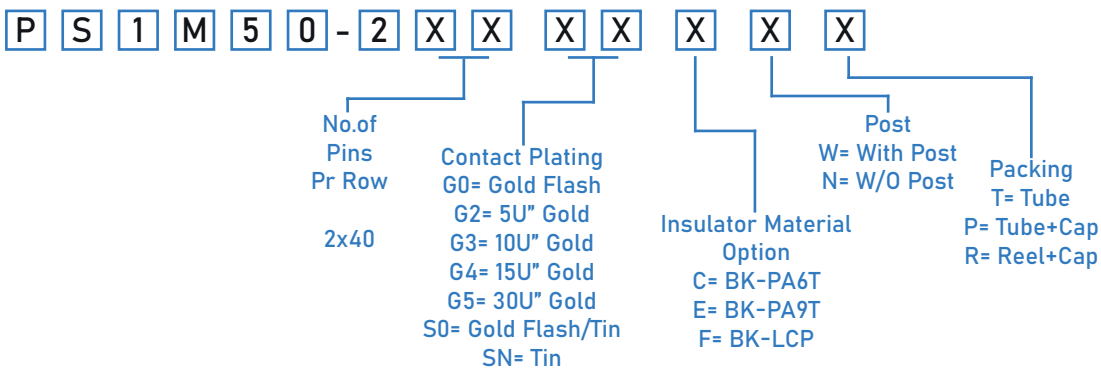

Recommended P.C.B Layout(Top Side)
 (PCB BOARD TOLERANCE±0.05)

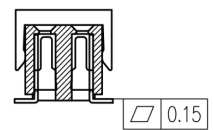
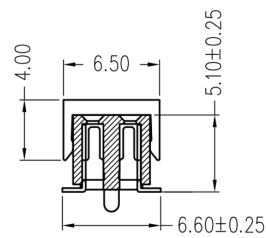
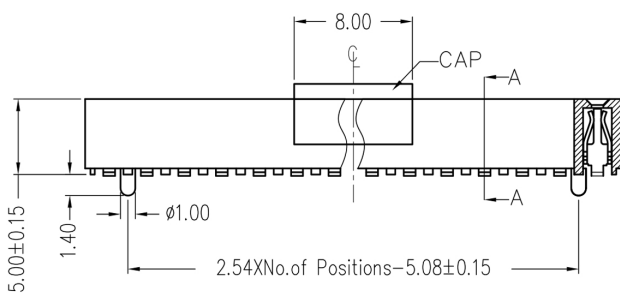
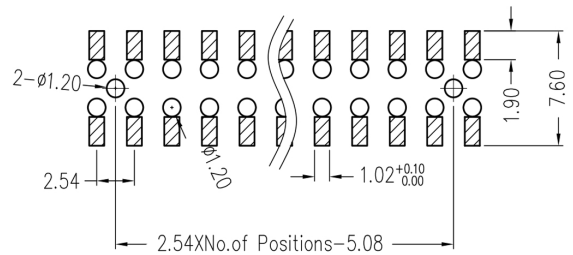

TYPE 2 WITH POST

TYPE 1 W/O POST

SECTION: A-A